

ZAVIO
www.zavio.com



M510W
Hardware User Manual

M510W Wireless Pan/Tilt IP Camera

Hardware User Manual

-Contents-

Statement and Declaration	2
CHAPTER 1. SAFETY INSTRUCTION	6
CHAPTER 2. INTRODUCTION	8
CHAPTER 3. PACKAGE CONTENTS	9
CHAPTER 4. PHYSICAL DESCRIPTION	10
CHAPTER 5. BASIC CONNECTION	11
5.1 WIRE CONNECTION	12
5.2 WIRELESS CONNECTION	12
CHAPTER 6. APPLICATION	13

Europe – EU Declaration of Conformity









This device complies with the essential requirements of the R&TTE Directive 1999/5/EC. The following test methods have been applied in order to prove presumption of conformity with the essential requirements of the R&TTE Directive 1999/5/EC:









Clause	Description
EN 60950-1: 2001	Safety of Information Technology Equipment
EN 50392: 2004	Generic standard to demonstrate the compliance of electronic and electrical apparatus with the basic restrictions related to human exposure to electromagnetic fields (0 Hz - 300 GHz)
EN 300 328 V1.6.1 (2004-11)	Electromagnetic compatibility and Radio spectrum Matters (ERM); Wideband transmission systems; Data transmission equipment operating in the 2,4 GHz ISM band and using wide band modulation techniques; Harmonized EN covering essential requirements under article 3.2 of the R&TTE Directive
EN 301 489-17 V1.2.1 (2002-08) and EN 301 489-1 V1.5.1 (2004-11)	Electromagnetic compatibility and Radio spectrum Matters (ERM); ElectroMagnetic Compatibility (EMC) standard for radio equipment and services; Part 17: Specific conditions for 2,4 GHz wideband transmission systems and 5 GHz high performance RLAN equipment

This device is a 2.4 GHz wideband transmission system (transceiver), intended for use in all EU member states and EFTA countries, except in France and Italy where restrictive use applies.

In Italy the end-user should apply for a license at the national spectrum authorities in order to obtain authorization to use the device for setting up outdoor radio links and/or for supplying public access to telecommunications and/or network services.

This device may not be used for setting up outdoor radio links in France and in some areas the RF output power may be limited to 10 mW EIRP in the frequency range of 2454 – 2483.5 MHz. For detailed information the end-user should contact the national spectrum authority in France.

 Český [Czech]	<i>[Jméno výrobce]</i> tímto prohlašuje, že tento <i>[typ zařízení]</i> je ve shodě se základními požadavky a dalšími příslušnými ustanoveními směrnice 1999/5/ES.
 Dansk [Danish]	Undertegnede <i>[fabrikantens navn]</i> erklærer herved, at følgende udstyr <i>[udstyrets typebetegnelse]</i> overholder de væsentlige krav og øvrige relevante krav i direktiv 1999/5/EF.
 Deutsch [German]	Hiermit erkläre <i>[Name des Herstellers]</i> , dass sich das Gerät <i>[Gerätetyp]</i> in Übereinstimmung mit den grundlegenden Anforderungen und den übrigen einschlägigen Bestimmungen der Richtlinie 1999/5/EG befindet.
 Eesti [Estonian]	Käesolevaga kinnitab <i>[tootja nimi = name of manufacturer]</i> seadme <i>[seadme tüüp = type of equipment]</i> vastavust direktiivi 1999/5/EÜ põhinõuetele ja nimetatud direktiivist tulenevatele teistele asjakohastele sätetele.
 English	Hereby, <i>[name of manufacturer]</i> , declares that this <i>[type of equipment]</i> is in compliance with the essential requirements and other relevant provisions of Directive 1999/5/EC.
 Español [Spanish]	Por medio de la presente <i>[nombre del fabricante]</i> declara que el <i>[clase de equipo]</i> cumple con los requisitos esenciales y cualesquiera otras disposiciones aplicables o exigibles de la Directiva 1999/5/CE.
 Ελληνική [Greek]	ΜΕ ΤΗΝ ΠΑΡΟΥΣΑ <i>[name of manufacturer]</i> ΔΗΛΩΝΕΙ ΟΤΙ <i>[type of equipment]</i> ΣΥΜΜΟΡΦΩΝΕΤΑΙ ΠΡΟΣ ΤΙΣ ΟΥΣΙΩΔΕΙΣ ΑΠΑΙΤΗΣΕΙΣ ΚΑΙ ΤΙΣ ΛΟΙΠΕΣ ΣΧΕΤΙΚΕΣ ΔΙΑΤΑΞΕΙΣ ΤΗΣ ΟΔΗΓΙΑΣ 1999/5/EK.
 Français [French]	Par la présente <i>[nom du fabricant]</i> déclare que l'appareil <i>[type d'appareil]</i> est conforme aux exigences essentielles et aux autres dispositions pertinentes de la directive 1999/5/CE.
 Italiano [Italian]	Con la presente <i>[nome del costruttore]</i> dichiara che questo <i>[tipo di apparecchio]</i> è conforme ai requisiti essenziali ed alle altre disposizioni pertinenti stabilite dalla direttiva 1999/5/CE.
Latviski [Latvian]	Ar šo <i>[name of manufacturer / izgatavotāja nosaukums]</i> deklarē, ka <i>[type of equipment / iekārtas tips]</i> atbilst Direktīvas 1999/5/EK būtiskajām prasībām un citiem ar to saistītajiem noteikumiem.
Lietuvių [Lithuanian]	Šiuo <i>[manufacturer name]</i> deklaruoja, kad šis <i>[equipment type]</i> atitinka esminius reikalavimus ir kitas 1999/5/EB Direktyvos nuostatas.

 Nederlands [Dutch]	<p>Hierbij verklaart [<i>naam van de fabrikant</i>] dat het toestel [<i>type van toestel</i>] in overeenstemming is met de essentiële eisen en de andere relevante bepalingen van richtlijn 1999/5/EG.</p>
 Malti [Maltese]	<p>Hawnhekk, [<i>isem tal-manifattur</i>], jiddikjara li dan [<i>il-mudel tal-prodott</i>] jikkonforma mal-ħtiġijiet essenzjali u ma provvedimenti oħrajn rilevanti li hemm fid-Dirrettiva 1999/5/EC.</p>
 Magyar [Hungarian]	<p>Alulírott, [<i>gyártó neve</i>] nyilatkozom, hogy a [<i>... típus</i>] megfelel a vonatkozó alapvető követelményeknek és az 1999/5/EC irányelv egyéb előírásainak.</p>
 Polski [Polish]	<p>Niniejszym [<i>nazwa producenta</i>] oświadczam, że [<i>nazwa wyrobu</i>] jest zgodny z zasadniczymi wymogami oraz pozostałymi stosownymi postanowieniami Dyrektywy 1999/5/EC.</p>
 Português [Portuguese]	<p>[<i>Nome do fabricante</i>] declara que este [<i>tipo de equipamento</i>] está conforme com os requisitos essenciais e outras disposições da Directiva 1999/5/CE.</p>
 Slovensko [Slovenian]	<p>[<i>Ime proizvajalca</i>] izjavlja, da je ta [<i>tip opreme</i>] v skladu z bistvenimi zahtevami in ostalimi relevantnimi določili direktive 1999/5/ES.</p>
<p>Slovensky [Slovak]</p>	<p>[<i>Meno výrobcu</i>] týmto vyhlasuje, že [<i>typ zariadenia</i>] spĺňa základné požiadavky a všetky príslušné ustanovenia Smernice 1999/5/ES.</p>
 Suomi [Finnish]	<p>[<i>Valmistaja = manufacturer</i>] vakuuttaa täten että [<i>type of equipment = laitteen tyyppimerkintä</i>] tyypinen laite on direktiivin 1999/5/EY oleellisten vaatimusten ja sitä koskevien direktiivin muiden ehtojen mukainen.</p>
 Svenska [Swedish]	<p>Härmed intygar [<i>företag</i>] att denna [<i>utrustningstyp</i>] står i överensstämmelse med de väsentliga egenskapskrav och övriga relevanta bestämmelser som framgår av direktiv 1999/5/EG.</p>

Federal Communication Commission Interference Statement

This equipment has been tested and found to comply with the limits for a Class B digital device, pursuant to Part 15 of the FCC Rules. These limits are designed to provide reasonable protection against harmful interference in a residential installation. This equipment generates, uses and can radiate radio frequency energy and, if not installed and used in accordance with the instructions, may cause harmful interference to radio communications. However, there is no guarantee that interference will not occur in a particular installation. If this equipment does cause harmful interference to radio or television reception, which can be determined by turning the equipment off and on, the user is encouraged to try to correct the interference by one of the following measures:

- Reorient or relocate the receiving antenna.
- Increase the separation between the equipment and receiver.
- Connect the equipment into an outlet on a circuit different from that to which the receiver is connected.
- Consult the dealer or an experienced radio/TV technician for help.

This device complies with Part 15 of the FCC Rules. Operation is subject to the following two conditions:

- (1) This device may not cause harmful interference, and
- (2) this device must accept any interference received, including interference that may cause undesired operation.

FCC Caution:

Any changes or modifications not expressly approved by the party responsible for compliance could void the user's authority to operate this equipment.

IEEE 802.11b or 802.11g operation of this product in the U.S.A. is firmware-limited to channels 1 through 11.

IMPORTANT NOTE:

FCC Radiation Exposure Statement:

This equipment complies with FCC radiation exposure limits set forth for an uncontrolled environment. This equipment should be installed and operated with minimum distance 20cm between the radiator & your body.

This transmitter must not be co-located or operating in conjunction with any other antenna or transmitter.

Hardware User Manual

Chapter 1. Safety Instruction

➤ **Before you use this product**

This product has been designed with safety in mind. However, the electrical products can cause fires which may lead to serious body injury if not used properly. To avoid such accidents, be sure to heed the following.

➤ **Legal Caution**

Video and audio surveillance can be forbidden by laws that vary from country to country. Check the laws in your local region before using this product for surveillance purposes.

➤ **Don't open the housing of the product**

Don't try to open the housing or remove the covers which may expose yourself to dangerous voltage or other hazards.

➤ **Don't use the accessories not recommend by the manufacturer**

➤ **Heed the safety precautions**

Be sure to follow the general safety precautions and the "Operation Notice."

➤ **Operation Notice - Operating or storage location**

Avoid operating or storing the camera in the following locations:

- Extremely hot or cold places
(Operating temperature: 0 °C to + 50 °C [32 °F to 122°F])
- Exposed to direct sunlight for a long time, or close to heating equipment (e.g., near heaters)
- Close to water (e.g., near a bathtub, kitchen sink, laundry tub)
- Close to sources of strong magnetism
- Close to sources of powerful electromagnetic radiation, such as radios or TV transmitters
- Locations subject to strong vibration or shock

➤ **In case of a breakdown**

In case of system breakdown, discontinue use and contact your authorized dealer.

➤ **In case of abnormal operation**

- If the unit emits smoke or an unusual smell,
- If water or other foreign objects enter the cabinet, or
- If you drop the unit or damage the cabinet: 1 Disconnect the cable and the connecting cables. 2 Contact your authorized dealer or the store where you purchased the product.

➤ **Transportation**

When transporting the camera, repack it as originally packed at the factory or in materials of equal quality.

➤ **Ventilation**

To prevent heat buildup, do not block air circulation around the device.

➤ **Cleaning**

- Use a soft, dry cloth to clean the external surfaces of the device. Stubborn stains can be removed using a soft cloth dampened with a small quantity of detergent solution, then wipe dry.
- Do not use volatile solvents such as alcohol, benzene or thinners as they may damage the surface.

Chapter 2. Introduction

The M510W Wireless Pan/Tilt IP Camera provides full overview and true day/night capabilities to be the perfect solution for indoor applications that need to cover everything at anytime, but still be cost-effective.



Key Features:

- Simultaneous MPEG-4 and Motion JPEG video stream
- Excellent Image Quality up to flexible 30 fps in all resolution for optimum bandwidth use
- Synchronized Two-way Audio with built in Microphone
- Wireless(IEEE 802.11g/b) Networks Connection
- Optimal Synchronization of Audio and Video
- **Support Live Video Viewing on Windows Live Messenger (WLM)**
- **Control panel add-in, i.e. snapshot, image setup, PT control**
- **Support Mac OS Browser**
- **Support iPhone through Safari Browser**
- Digital Input / Output Port for External Alarm & Sensor
- Mobile Phone Streaming Live Video through 3GPP / ISMA / RTSP
- Mobile Phone Live Image through 2.5 WAP
- Multi-level Password Protection for Restricting Camera Access
- Built-In Multi-Window Motion Detection (3 detection areas)
- Video Buffer makes the Streaming Smoother
- **UPnP and Bonjour** for Fast and Easy Installation
- DDNS Supported
- Bundled 16 Channel Surveillance Software
- User-friendly & Multi-lingual UI

Chapter 3. Package Contents



Camera – M511W Wireless Day / Night Pan / Tilt IP Camera

Quick Installation Guide - To provide brief product information and quick installation and wireless setting

Software CD - To provide IP Surveillance Software, Intelligence IP Installer, User Manuals, and Language Packs

Component Pack -Camera mount Kit & Pads (one bracket and two packs of screws) 、 Antenna

Adaptor - 12V DC, max 6W

Chapter 4. Physical Description

Overview

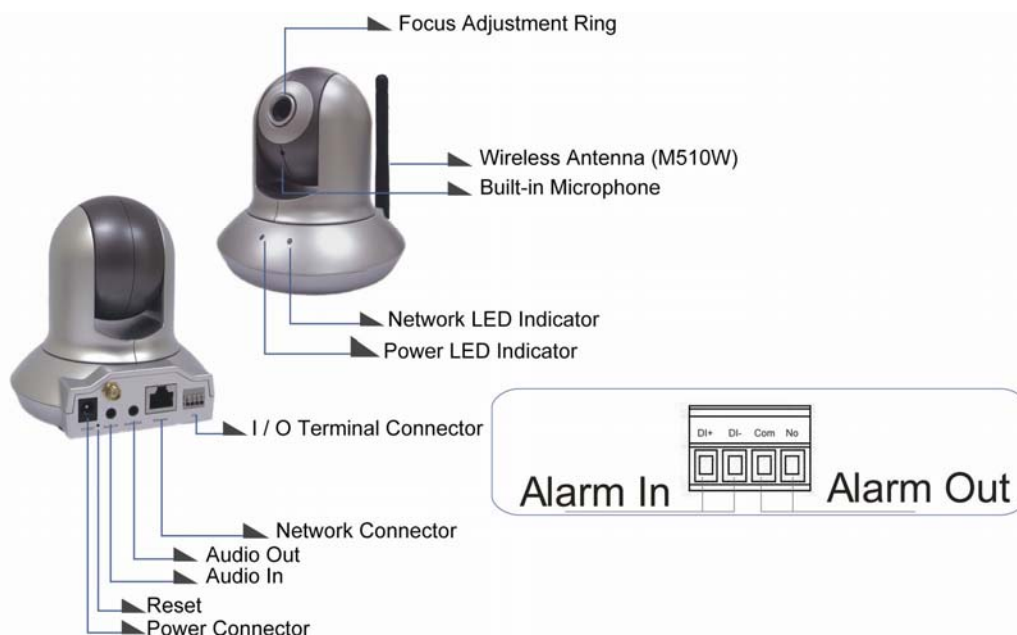

- **Focus Adjustment Ring** - Adjust focus manually to achieve the best image quality
- **Wireless Antenna** - For connection of IEEE 802.11 b / g wireless network.
- **Built-In Microphone** - Built-In Microphone for Two-way Audio
- **Network LED indicator** - Network LED will light up after connecting with network.
- **Power LED indicator** - Power LED will light up after completing the boot process.
- **Power Connector** - For connection of 12V DC input.
- **Reset** - When the device is empowered, press the Reset Button to reboot the device, or hold the Reset Button for 10 seconds to set the device settings back to factory default
- **Audio In** -To support audio in with Microphone for two way audio
- **Audio Out** - To support audio out with earphones or speakers for two way audio
- **Network Connector** - For connection to the Ethernet via RJ-45 standard with PoE
- **I / O Terminal Connector** - 1Input / 1Output to support External Alarm and Sensor used for motion detection, event triggering and alarm notification...etc.

DI / DO Terminal connector diagram

Please refer the following illustration below for connection method.

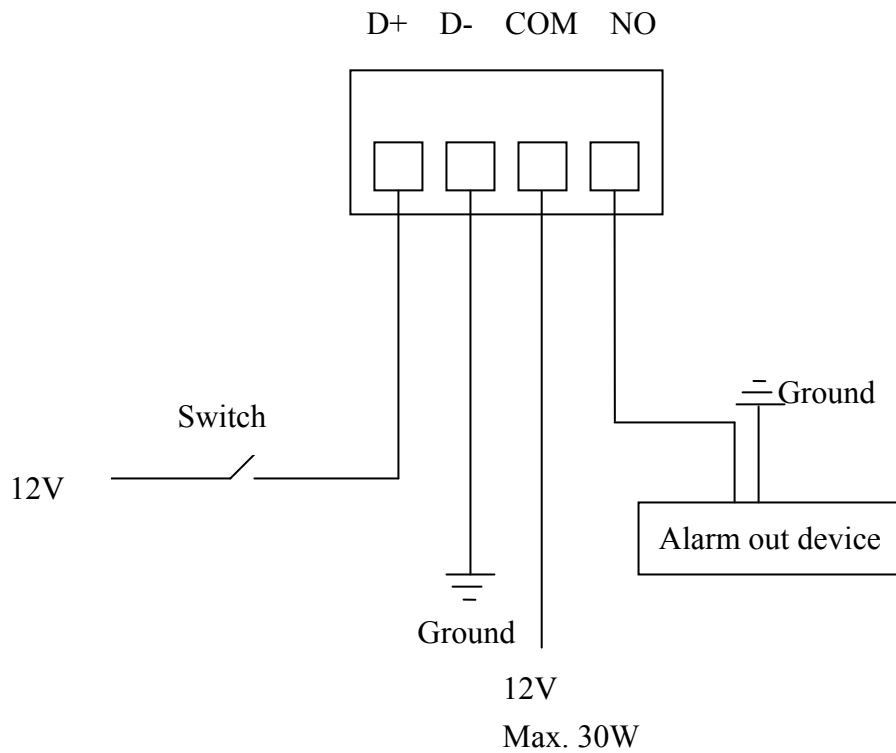

Chapter 5. Basic Connection

M510W is for both wire and wireless connection. You can follow the procedure below to connect the IP Camera with power and Ethernet for both wire and wireless connection.

5.1 Wire Connection

1. Connect the power adaptor to IP Camera.
2. Connect IP Camera' Ethernet port to your Hub/ Switch / Router

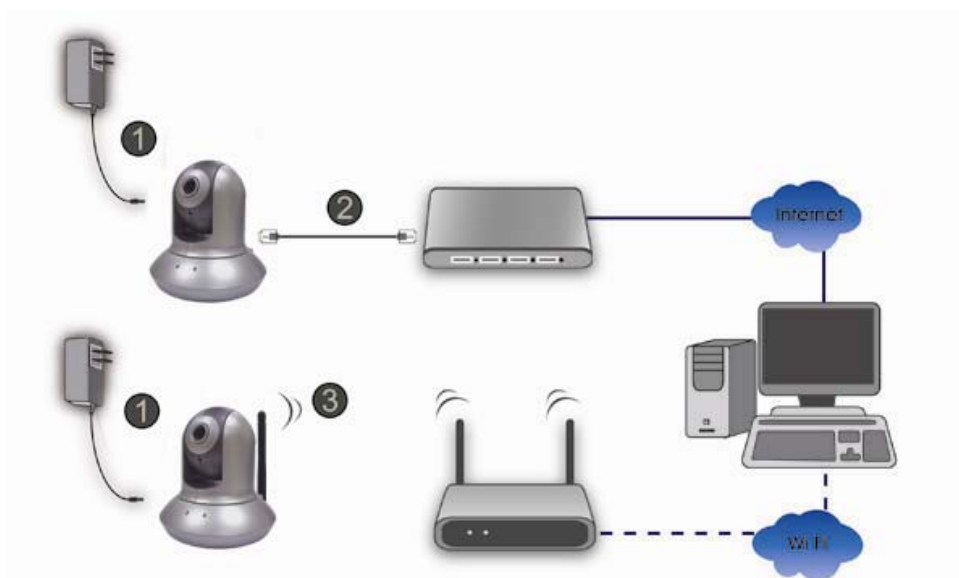

5.2 Wireless connection

1. Connect the power adaptor to IP Camera.
3. Connect to Wi-Fi

Chapter 6. Application

